

# M40 Series Industrial Videoscope



Strong Environmental Adaptability  
Reliable Operation System  
Flexible Configuration

# PRODUCT INTRODUCTION

## M40 Series Industrial Videoscope

The M40 Series is an upgraded product based on the C40. It is a high-definition, modular handheld industrial borescope. Building on its portable design, it features a larger industrial touchscreen and a more versatile modular probe and lens system, enhancing inspection adaptability and operational efficiency. It is suitable for visual inspection and diagnosis of complex internal structures.



- |                                |                        |                          |
|--------------------------------|------------------------|--------------------------|
| ① Power Button / Freeze        | ⑥ Down Button          |                          |
| ② Return Button                | ⑦ Joystick             |                          |
| ③ Brightness Adjustment Button | ⑧ Photo / Video Button | ⑪ Type-C Port            |
| ④ OK / Menu Button             | ⑨ Headphone Jack       | ⑫ HDMI Port              |
| ⑤ Up / Photo-Video Switch      | ⑩ TF Card Slot         | ⑬ Probe Locking Ring     |
|                                |                        | ⑭ Battery Release Button |



5-inch HD touchscreen

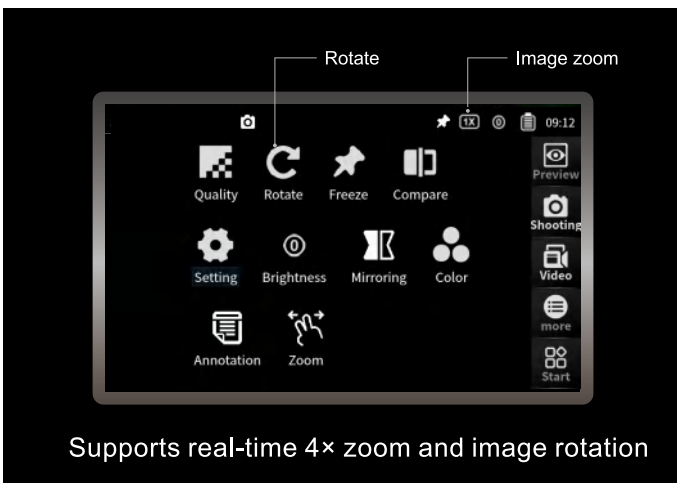

Supports real-time 4× zoom and image rotation

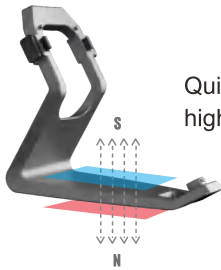

Quick-release high-strength magnetic base

## Strong Environmental Adaptability and Reliable Operation /02

- **IP68 waterproof probe**

Suitable for harsh conditions such as moisture, oil contamination, and underwater environments.

- **Quick-release high-strength magnetic base**

Provides stable support and enables fast adjustment of inspection angles.

- **High-strength aluminum alloy quick-release heat-dissipation probe connector**

Heat dissipation efficiency increased by three times, ensuring stable performance during extended operation.

- **Main unit weight: 0.89kg (including base and battery)**

Lightweight and portable, suitable for prolonged handheld use.

- **Built-in replaceable 5000mAh lithium battery**

Approximately 4 hours of battery life, meeting continuous on-site inspection demands.

# TECHNICAL FEATURE

M40 Series Industrial Videoscope

## Touch Interaction System /01

- **5-inch touchscreen (800×480 resolution)**

Provides clear image display for direct on-site observation and evaluation.

- **Supports real-time 4× zoom and image rotation**

Allows instant magnification of details and multi-angle viewing from 0° to 270°, meeting various inspection perspective requirements.

- **Photo capture, video recording, and real-time annotation**

Supports storage in JPEG / BMP / MP4 formats. Time stamps and annotations can be added to images and videos for documentation and report generation.

- **More than ten system languages available**

Meets the needs of multi-region and multilingual operating environments.

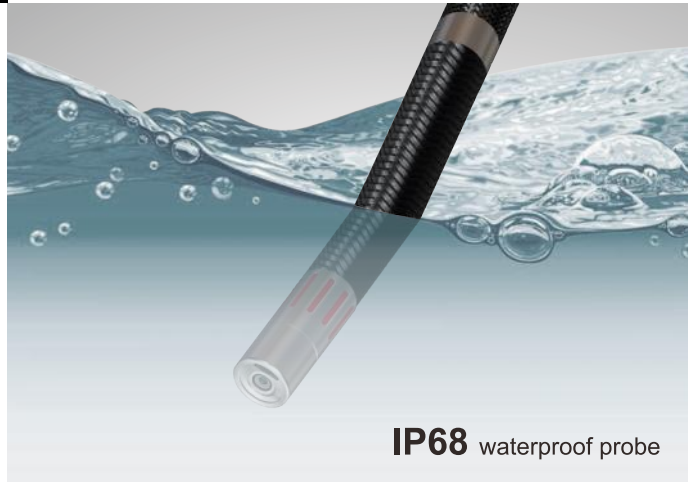

IP68 waterproof probe



Magnetic base

lithium battery

# Modular Inspection /03 System and Flexible Configuration

- Supports quick replacement of probes with various diameters. Adapts to different bore sizes and depth inspection requirements.
- Multiple interchangeable lenses available, including direct-view, side-view, and dual focus options. Flexible selection according to inspection targets, enabling multifunctional coverage with a single device.
- 360° omnidirectional probe articulation with mechanical control. Allows flexible maneuvering within pipes and cavities.



360° all-way articulation

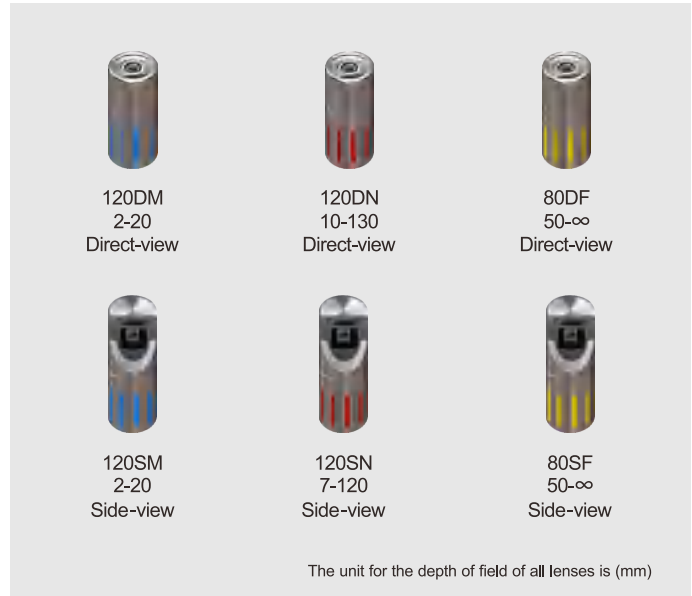
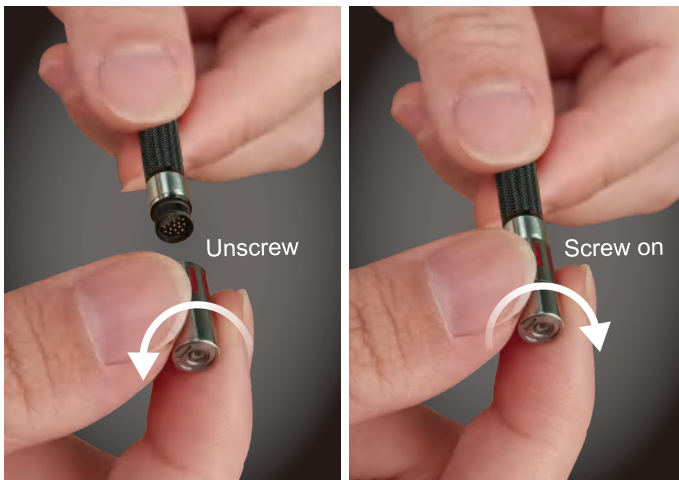
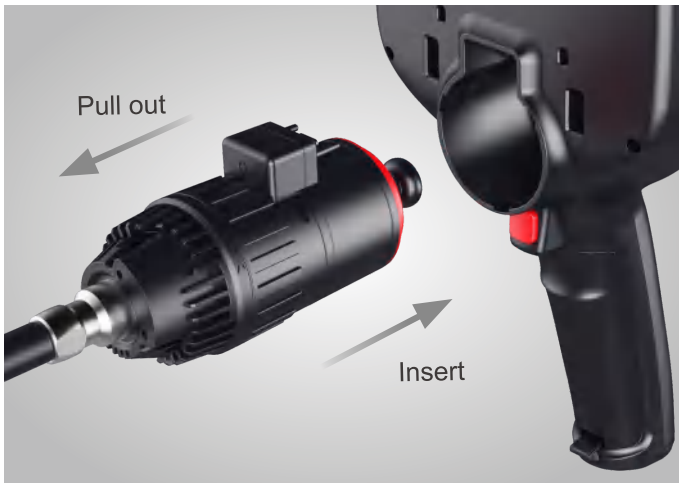

φ0.95mm	L: 1-2m	DOF: 3-50mm	FOV: 120°
φ1.2mm	L: 1-2m	DOF: 5-50mm	FOV: 120°
φ1.6mm	L: 1-3m	DOF: 5-50mm	FOV: 120°
φ1.8mm	L: 1-3m	DOF: 5-50mm	FOV: 120°
φ2.0mm	L: 1-3m	DOF: 5-50mm	FOV: 120°
φ2.8mm	L: 1-3m	DOF: 5-50mm	FOV: 120°
φ3.0mm	L: 1-1.5m	DOF: 3-50mm	FOV: 130°
φ3.9mm	L: 1-3m	DOF: 3-100mm	FOV: 120°
φ4.8mm	L: 1-3m	DOF: 10-100mm	FOV: 100°
φ6.0mm	L: 1-10m	DOF: 8-80/10-100/15-130/15-∞(mm)	FOV: 100°/105°/120°

For detailed specifications and additional requirements, please consult our sales representatives.

# OPERATIONAL SCENARIOS

M40 Series Industrial Videoscope

## Widely Applied :

### **Aerospace:**

Internal defect detection for engine blades, combustion chambers, turbine structures, fuel nozzles, etc.

---

### **Automotive Manufacturing:**

Inspection of engine block, valves, and internal cleanliness and assembly status of transmission.

---

### **Nergy and Power:**

Internal inspection of boiler pipelines, heat exchangers, transformer oil tanks, and wind turbine gearboxes.

---

### **Etrochemical:**

Pipeline and tank inspection at refineries, reactor and heat exchanger inspection at chemical plants, maintenance of oil and gas transmission pipelines.

---

### **Rail Transit:**

Evaluation of internal conditions of bogie hollow shafts, brake system piping, and air conditioning ducts.

---

### **Construction Engineering:**

Detection of internal cavities, clogged drainage pipes, and dust accumulation in ventilation systems for concrete structures.

---

### **Special Equipment:**

Regular inspection and safety assessment of pressure vessels, boilers, and pressure pipelines.

---

### **Military Industry and Research:**

Internal inspection of weapon components, material structure observation, and teaching experimental demonstrations.

---

# SPECIFICATION PARAMETERS

## M40 Series Industrial Videoscope

Host	
Display Dimension	5-inch HD touchscreen
Display Resolution	800 × 480
Image Zoom	Supports real-time 4× zoom; up to 5× zoom during image playback
LED Brightness Levels	Adjustable from 0 to 9 levels
Auxiliary Measurement	Function Crosshair reference line
Photo/Video	Supports photo capture and video recording
Document Format	Images stored in JPEG / BMP format; videos in MP4 format
Image Rotation	0° / 90° / 180° / 270° rotation
Image Preview	List-view preview; supports full-screen viewing, file deletion, time watermarking, etc.
Screen Backlight Brightness	700nit high-brightness sunlight screen
Output Port	Mini HDMI
Menu Language	Simplified Chinese, Traditional Chinese, English, Japanese, Korean, French, German, Portuguese, Spanish, Russian, Italian, Dutch, etc, more than ten languages
Host Dimension	295 mm × 140 mm × 80 mm
Package Dimension	425mm × 345mm × 188mm
Host Weight	0.89 kg (including base and battery)
Tube	
High-strength aluminum alloy quick-release heat-dissipation replaceable structure	
*Probe Diameter(±0.1mm)	Φ0.95mm   Φ1.2/1.6mm   Φ1.8/2.0mm   Φ2.8mm   Φ3.9mm   Φ4.8mm   Φ6.0mm
*Camera Pixels	160,000   160,000   160,000   160,000   1,000,000   1,000,000   1,000,000 2,000,000
View Direction	Forward   Forward   Forward   Forward/Side   Forward/Side   Forward/Side   Forward/Side
*Depth of Field(mm)	3-50   5-50   5-50   5-50   5-100   8-80   8-80 / 15-∞
*Field of View	120°   120°   120°   120° / 120°   120° / 70°   120° / 70°   120° / 70°
*Tube Length	1-1.5m   1-2m   1-3m   1-5m   1-3m   1-3m   1-10m
Lighting Mode	Fiber+backend LED   Front LED   Front LED   Front LED / Fiber+backend LED
Joystick Control	Non-articulation   Non-articulation /Two-way   360° all-way articulation
*Probe Bending Angle	/   /   Tube length≤3m,150°;Tube length 3m to 5m,120°;Tube length≥7m,90°
Tube Material	Alloy spring tube   Tungsten braided wear-resistant tube
Probe Material	Hard alloy protective shell
Joystick Control	Mechanical control,The rocker comes with a Dnison tight adjustment
Compatibility	Interchangeable Tube
Protective Device	Buffer for connecting host and wear-resistant tube
Probe Waterproof Level	/   /   /   IP68
Lens System	
Interchangeable	
Lens Model	Direct View   Side View
Depth of Field (mm)	2-20 / 10-130 / 50-∞   2-20 / 7-120 / 50-∞
Field of View (°)	120 / 120 / 80   120 / 120 / 80
Power	
Power Supply	Rechargeable lithium battery (with reverse battery protection.)

<b>Power</b>	
Battery	3.7V,5000mAh
System Operating Time	4 hours

<b>Operation Environment</b>	
System Operating Temperature	-10°C-50°C
Probe Operating Temperature	-20°C-85°C
Storage Temperature	-20°C-60°C
Relative Humidity	15%-90%

<b>Others</b>	
Base	Quick-release high-strength magnetic base

<b>Configurations</b>	
Standard Configurations	M40 videoscope ×1, instrument case ×1, magnetic base ×1, rechargeable lithium battery ×1,
	charger ×1, card reader ×1, 8G TF card ×1, anti-fall hand strap ×1, user manual ×1, usage
	precautions ×1

★ For specific parameters (such as illumination, depth of field, pixel, field of view, working length, bending angle, etc.) and other requirements, please contact relevant personnel for confirmation.

## **COANTEC LTD**

---

Floor 4, Block B, Building 5, Hengmingwan Chuanghui Center, Longping West Road,  
Longcheng Street, Longgang District, Shenzhen, China 518172

Tel: +86-755-89728626    Email: [coantec@126.com](mailto:coantec@126.com)    Web: [www.coantecndt.com](http://www.coantecndt.com)



Website

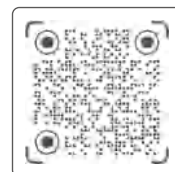

TikTok